

Offline 4 axis motion controller instruction manual

v0.5.8

2015-08-13

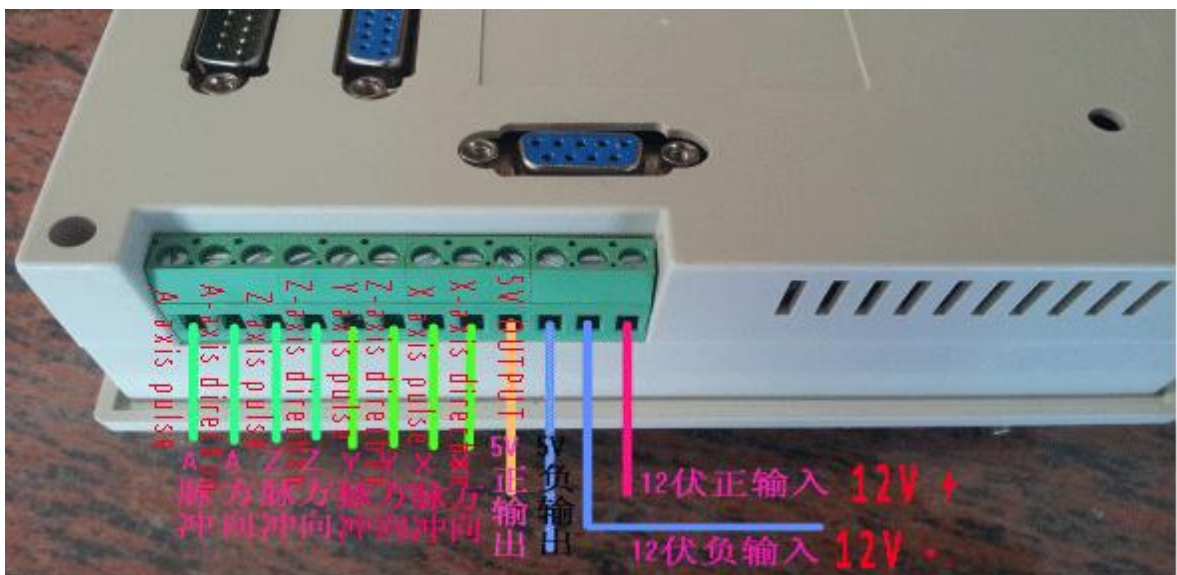

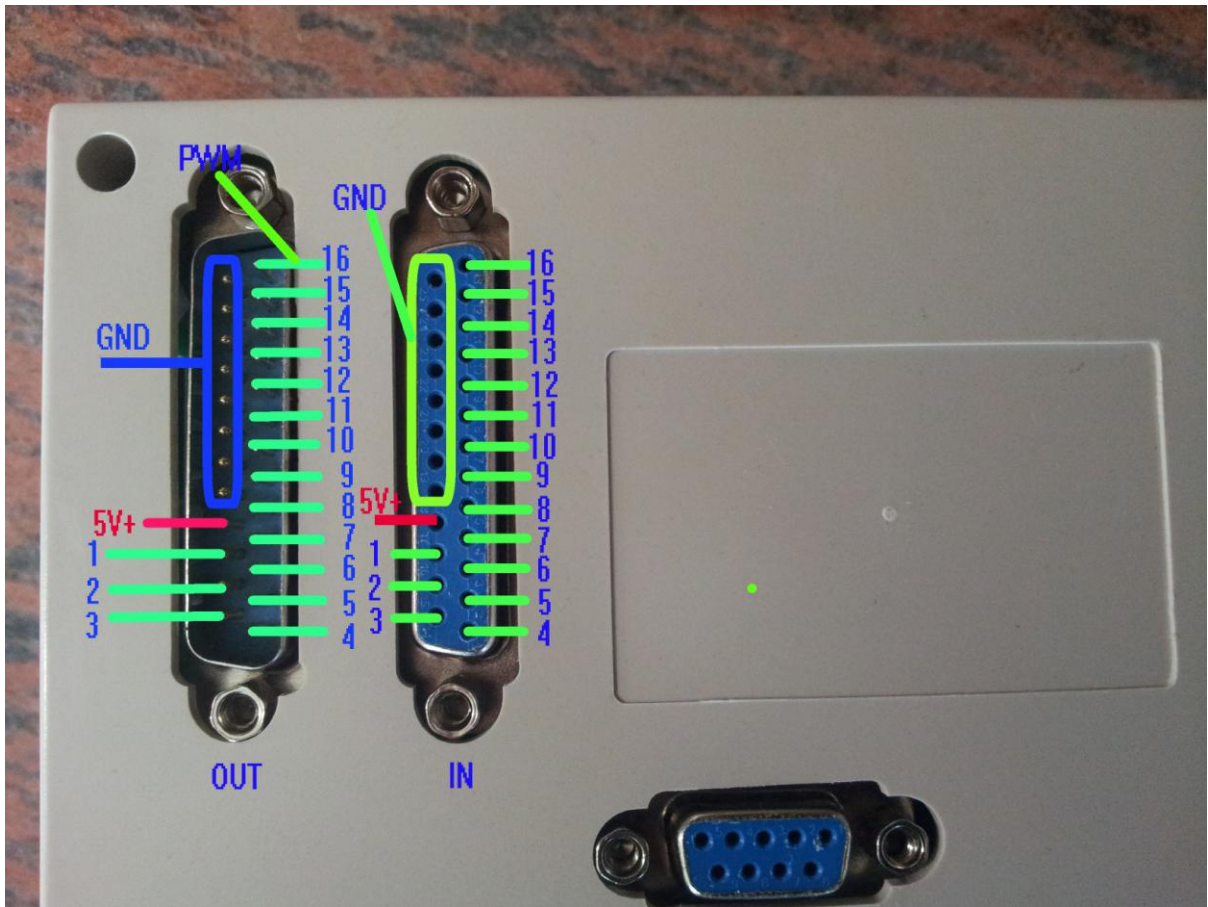

Interface Rendering

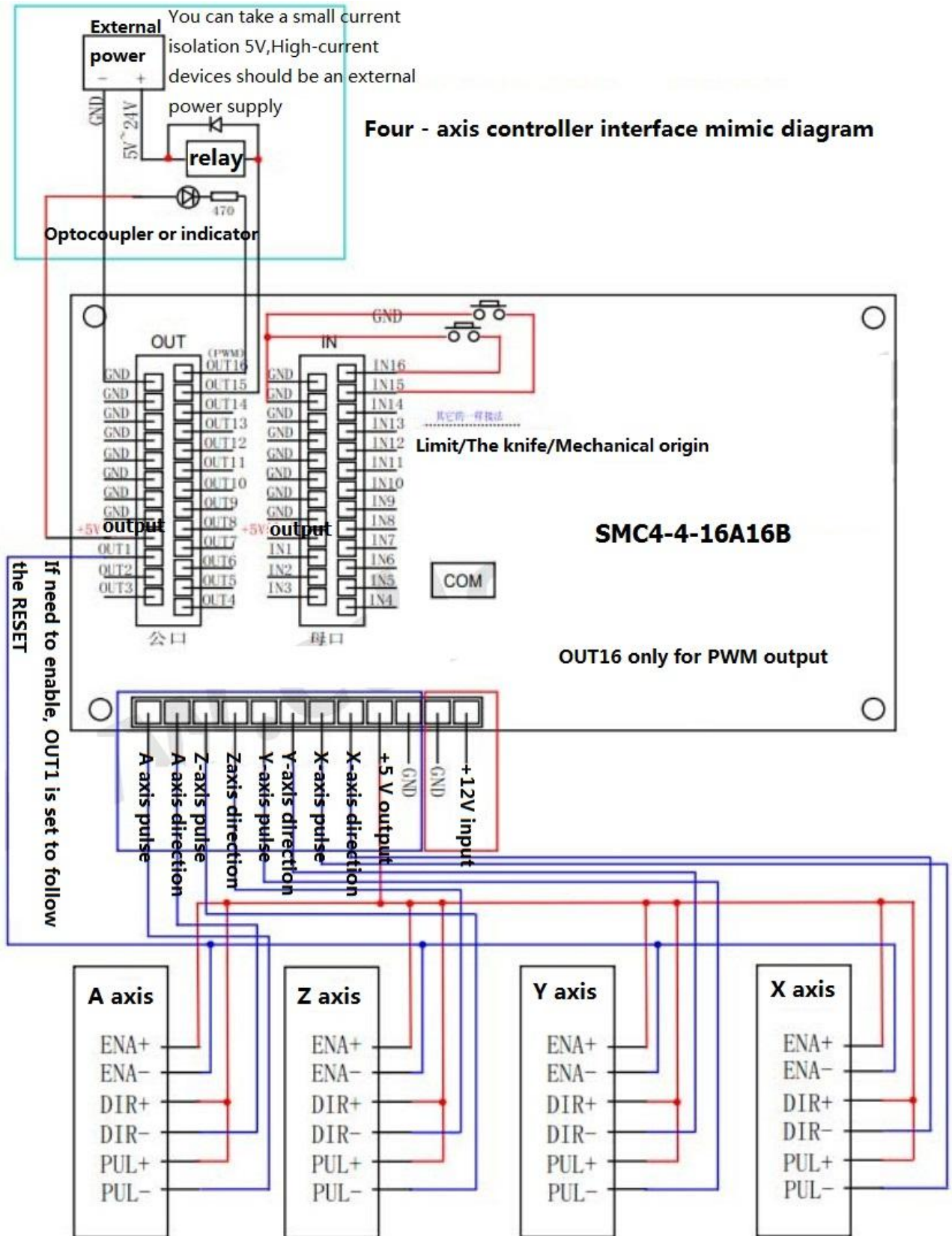

Power required to stabilize the direct pressure 12V, current should be greater than 1A, this controller is that the operating current 300MA-800MA

When access to power, be sure to distinguish between the positive and negative terminals!

Shown mimic diagram "5V 输出" means the output power, this current can be provided about the current 500MA to external devices so !!!!

G Code instruction

command	parameter	Features	Remark
G00	X. Y. Z. A.	Fast-moving machine	According to the maximum speed of the machine for fast moving
G01	X. Y. Z. A. F.	Processing Run	F value is limited
G02	X. Y. Z. A. F.	Clockwise circular machining	
G03	X. Y. Z. A. F.	Counterclockwise circular machining	
G04	P	Delay	P values affected
G17	(X, Y) Coordinate plane		
G18	(X, Z) Coordinate plane		
G19	(Y, Z) Coordinate plane		
G28	XYZA	Back to the mechanical origin	It can be controlled separately or in combination
	P1X*Y*Z*A*	Assigned to the current coordinates	
	P2X*Y*Z*A*	Plus given the current coordinate values	
	P3XYZA	Conditional back to mechanical origin	Only after the effective power back through mechanical origin, then call this function is invalid
G54		Workpiece coordinate 1	Memory workpiece origin and mechanical origin offset value

G55		Workpiece coordinate 2	Memory workpiece origin and mechanical origin offset value
G56		Workpiece coordinate 3	Memory workpiece origin and mechanical origin offset value
G57		Workpiece coordinate 4	Memory workpiece origin and mechanical origin offset value
G58		Workpiece coordinate 5	Memory workpiece origin and mechanical origin offset value
G59		Workpiece coordinate 6	Memory workpiece origin and mechanical origin offset value
G80		End drilling instructions	
G81	X. Y. Z. R. F	Drilling instruction	Universal drilling
G82	X. Y. Z. R. P. F	Drilling instruction	Controllable bottom residence time
G83	X. Y. Z. R. I. F	Drilling instruction	Row pin drilling

G Code instruction 2

instruction	parameter	Features	Remark
G90		Absolute value size	default
G91		Incremental dimension	

G Code instruction 3

instruction	parameter	Features	Remark
-------------	-----------	----------	--------

M00		Pause instruction	Until you press the start button to continue
M03		Spindle Forward	Affected delay parameters
M04		Spindle reversal	Affected delay parameters
M05		Spindle stop	
M07		Spray Open	Affected delay parameters
M08		Cooling Open	Affected delay parameters 响
M09		Meanwhile Close M07M08	
M30		The total program is stopped	
M47		Loop instruction	Return to the first line to run

A. Safety Precautions

Before using this control system, please read this manual carefully before do related operations. Carefully read the operating instructions and user Safety Precautions, the user should do the appropriate protection, take the necessary security measures before proceeding to operate. First time operation of the operator, should know the proper use of the corresponding functions, you can perform the appropriate action, For those unfamiliar the functions or parameters, Prohibited actions or change system parameters.

System maintenance:

When the system is under unusual circumstances, the need to repair the appropriate cable or socket connection, you should turn off power. And then make the necessary repair.

The operator has not been rigorously trained or authorized by the studio units or individuals, can not open the control system for maintenance operations, modification, repair, and other acts.

Other matters:

If there is any system functions is different from the manual, please with system software features to prevail.

Control system functions to change or improve (upgrade), without notice. If you have other requirements, please contact us.

B: Outline

Our latest "motion controller" using high-performance 32-bit CPU, with an LCD display, Humanized Window-type interface, Using external TF card memory, storage space than 2G, Operating voltage and control voltage using isolation mode, and touch keyboard. The system has high reliability, high precision, low noise, easy operation characteristics.

The controller can four simultaneous axes, multiple micro segment look ahead control algorithm, The controller can four simultaneous axes, multiple micro segment look ahead control algorithm, can be achieved with four - axis straight line interpolation and a micro multi-line multi-axis continuous interpolation, controlled by a breakpoint carving.

Simple, clear parameters for your convenience and fast operation. Input / output can be set up functions to facilitate your use and maintenance.

The main function

Parameter settings: You can set the processing and operations relating control parameters, Making process to achieve the best condition.

Manual operation: can be achieved manually, jog, back to procedure zero, back to mechanical zero, cleared coordinate operations.

Program Management: Program can create, delete, modify, read, preserve, automatic processing, continuous, and pause.

External Manual: a variety of external functions can be defined Manually, In order to facilitate the use of the freedom to select the input function: the limited input can achieve a variety of user needs.

System components

CNC system mainly consists of the following parts:

High-performance, high-speed 32-bit ARM CPU;

Liquid crystal display (resolution: 320 * 240);

Input / Output (16 channels opto-isolated 10MA inputs, 16 channels opto-isolated pull-down tank 500MA output).

Users machining program memory can be arbitrary Storage in TF card.

Technical indicators:

The smallest unit of data 0.0001mm

Conventional precision of plus or minus 2 PP amount pole

Even following the linear accuracy is one of the four corner points of the corner arch high

The maximum data size $\pm 99999.999\text{mm}$

Maximum pulse output frequency 50KHZ (three-axis simultaneous 50KHZ)

Control axes 4 axes (X, Y, Z, A)

4-axis intermodal and has a four-axis multi-micro multi-segment prospective interpolation control

Appearance and Panel: Dimensions: length 165, width 101, thickness 50

Appearance and Panel: Dimensions: length 165, width 101, thickness 50

Hole size: 157 * 93mm

External view





C. Operating Instructions

Boot screen

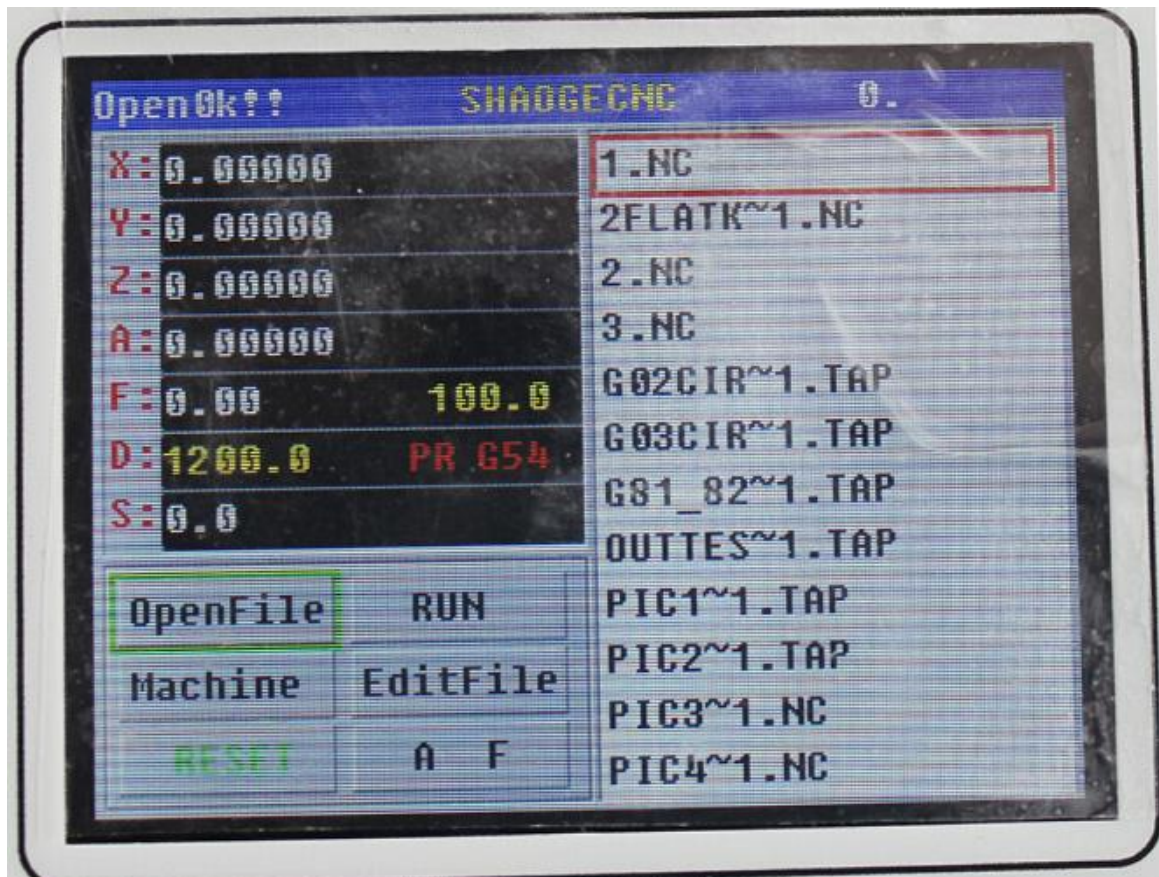

Function key area:

Open the file

Starts running

Advanced features

Document Management

RESET (RESET)

Jog

The following screen appears after the control system is powered

This boot interface is divided into four zones:

- the top district: the main display file name now opens, real-time the number of processing rows.
- the coordinate display area: The main display real-time three-axis coordinate and real-time processing speed.
- the function key area: the main control keys.
- file area: file name, or processed documents.

(Note: TF card support hot swap, when the new insert TF card, need to initialization after re-insert, so sometimes prompts OPENER, Just several times "open file" !)

Because the system requirements for the TF card data is extremely strict, so the general low-end cards (cottage card) will be excluded, and then replace the other genuine card reading! ! !

After the show !!!!! does not give the total number of files and the folders stored in the TF card is greater than 50

For HDSD (TF), because of the card problem, and can not fully understand, replace other cards and then read!

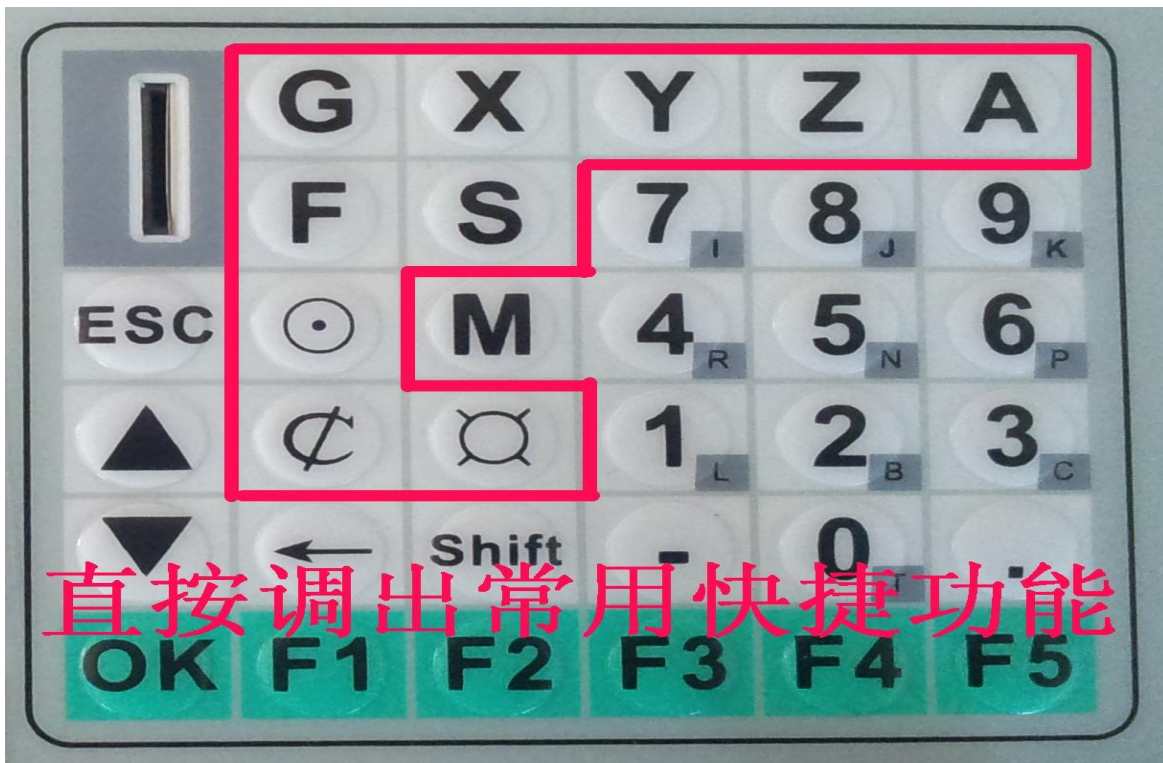

shortcut key ⊙ as "Origin Operation"

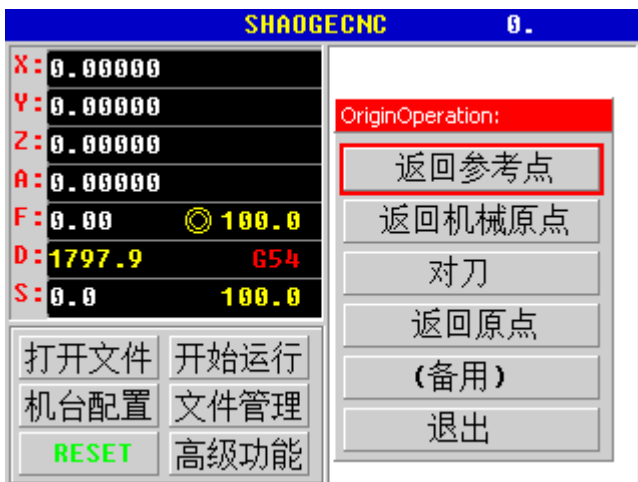

“返回参考点” Z-axis height to rise to safety, all other axes back to the specified location, Z axis return to the specified location (in the mechanical origin can be set at this point)

“返回原点” Z-axis height to rise to safety, XY axis back to square one, Z-axis and then passed back to the origin.

“返回机械原点” : Z axis mechanical origin retreated, Y-axis mechanical origin retreated, Y axis retreated mechanical origin,

(Please note that configuration pins, level and enable)

“对刀” Z axis decline (or increase), when it comes to the probe, after Stop running clearing the Z-axis coordinate for the knife offset, and Z-axis carrying knives have to bounce high end of this process.

(Please note that configuration pins, level and enable)

shortcut key  as "coordinate cleanup operations."



X axis triaxial cleared
 Y axis triaxial cleared
 Z axis triaxial cleared
 A axis uniaxial cleared
 All axes cleared
 drop out

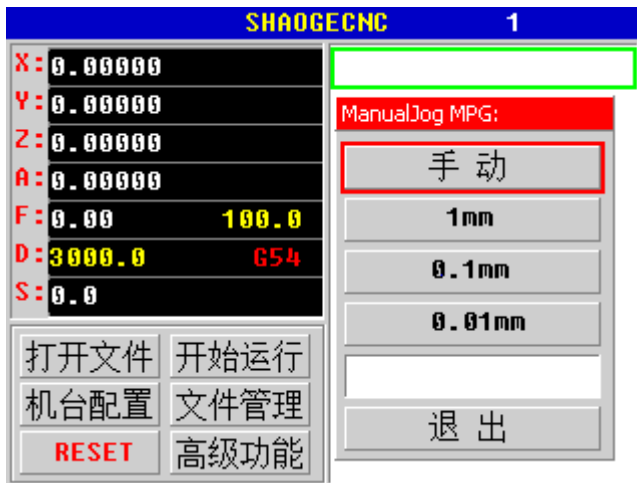

Panel shortcut key  "Jog"
 "Manual" Recovery Manual
 "1mm": When the time selected by pressing the corresponding arrow keys will move the corresponding length (incremental moves)
 If you want to move to a specific length, you can enter a specific number in the input basket, (only press "OK" to enter the basket after becomes yellow, green valid return), press the corresponding axis key, you can.

Corresponding to X + X-Y + Y-Z + Z-A + A- valid

Panel shortcut key  "direct coordinate operations"



"运行到到" The corresponding axis directly run the specified coordinates.
 "变更坐标": The axis corresponding number directly into the set (this action is irreversible, please carefully operation)

Panel shortcut key **S** as "Spindle Operation"

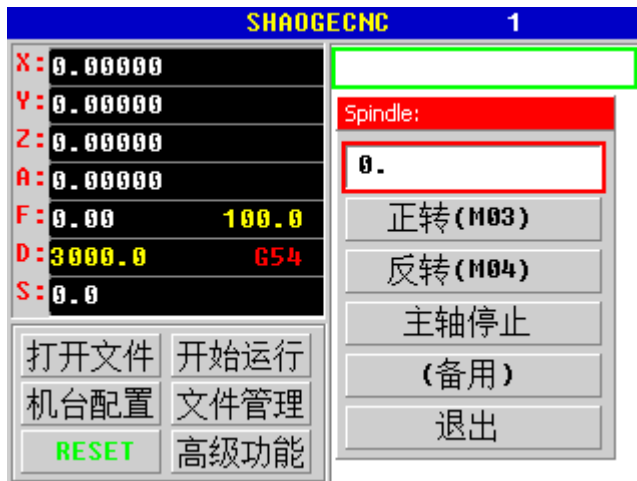

Input box to fill in the number of revolutions, the maximum value of this parameter can be set in the host settings.

Panel shortcut key **F** "Manual feed speed operation"



Value D shows box manual feed speed.



Panel shortcut key **G** "Workpiece coordinate system operator"

Selected G *, you can choose to sit workpiece coordinate system, the need to coordinate with the mechanical operations.

Click on the "machine configuration" below, then click "motor parameters" to enter the following picture



字意解释:

脉冲当量: The required number of pulses per unit length (pulse required for each millimeter) support floating point input

最高速度: Maximum speed of this motor can run (mm / min), when the input exceeds the maximum attainable system will press system can achieve maximum prevail. Ideal maximum value of 70%

More than the maximum 70% will prompt red warning

加速度: The maximum acceleration of the motor can run. This value is too small will seriously affect more corner speed micro segment

脉冲电平: 1 or 0, active high or active low, determined by the drive, most effective drive this value is 0.

方向电平: 1 or 0 active high or active low, this will change the direction of change

脉冲宽度: Pulse output valid time, only for a measure, under normal can be 0.

Values are as follows: $T = 4.3 \text{ sec} + 0.43 * N$ (the number of the selected)

Note Version V0.5.8 15_6_26 later.

Stepper motor driver pulse equivalent = number of subdivisions × (360 / stepper motor step angle) / screw pitch

Example: Stepping angle = 1.8 leadscrew = 5mm segments = 8

Pulse equivalent = $8 * (360 / 1.8) / 5 = 320$

Maximum speed value: To finalize the ability of the motor according to the principle of losing step, taking 70% of the maximum speed value, leaving 30% margin to the motor

T acceleration table is as follows:

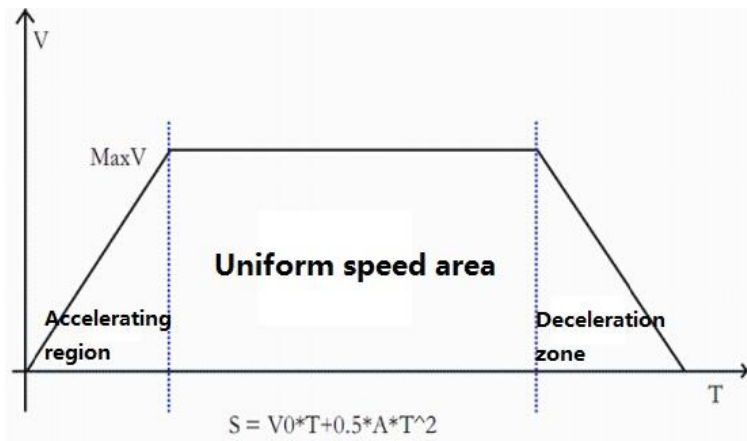

Acceleration values: the ability to be finalized in accordance with the motor, based on not falling out of step, take 70% of maximum speed values, leaving 30% margin to the motor (characteristics of stepper motor).

Pulse relationship level and pulse width (Note: The actual width is Given width Plus default width)

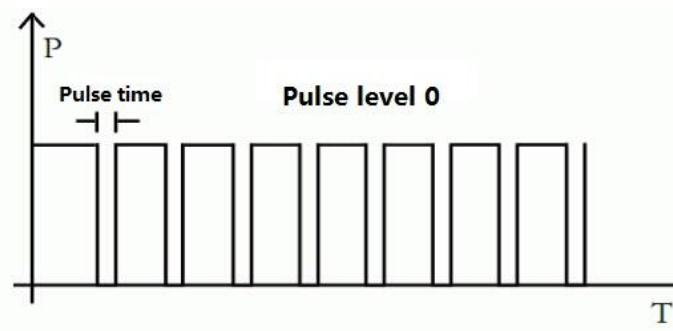
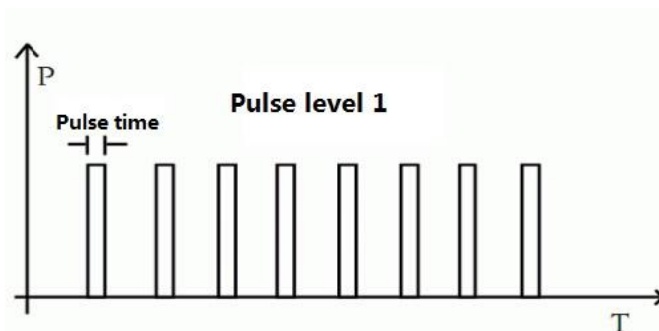

Direction level

When the direction level of 1, the shaft is running, the Output is high level, Anti-run is low level;

When the direction level of 0, the shaft is running, the Output is low level, Anti-run is high level.

About IO interface level set Description:

Running, back to the origin, all axes cleared, pause, back to the mechanical origin

1 normally open (press down turned, the red lights change), set the level to zero.

2 normally closed (goes off, black light turns red), set the level to 1. (Anti-interference strongest)

Emergency:

After connecting switch line, so that the switch is in the pop-up state, see "Test light"

If the light is red, set the level to 0.

If the lamp is black, set the level to 1.

Note: The pop-up state is working condition, is pressed into the self-locking emergency stop state.

Limit input:

- 1, normally open (when you hit the limit turned on the red light black light), set the level to 1.
- 2, normally closed (when you hit the limit off, black and red becomes red), set the level to zero.

Mechanical origin:

- 1, normally open (when you hit the limit turned on the red light black light), set the level to 1.
- 2, normally closed (when you hit the limit off, black and red becomes red), set the level to zero.

G script parameters:



G2/G3 超差: Enter the G02 / G03 after manual calculations or other calculation because of accuracy issues, so that the arc center is inconsistent with the values given at the moment, there is a fault-tolerant, the system will be based on the given parameters, recalculate the optimal center coordinate

弦长: System fitting curved arc chord when generating segment

精确停止: Open CVL control **CVL 控制:** Corner length restrictions

G1 分辨率: G01 minimum length, which is defined algorithm, users can use the default value: 0.0001

安全高度: Pause, or homing reference point, Z axis height elevation of security.

对刀偏移: The value of the Z-axis clear bias after the knife after 0, this value is mainly used for cutting height adjustment.

对刀弹回: After the knife, after the Z axis stopped, according to the value left on the knife, the knife

is easy to take away.

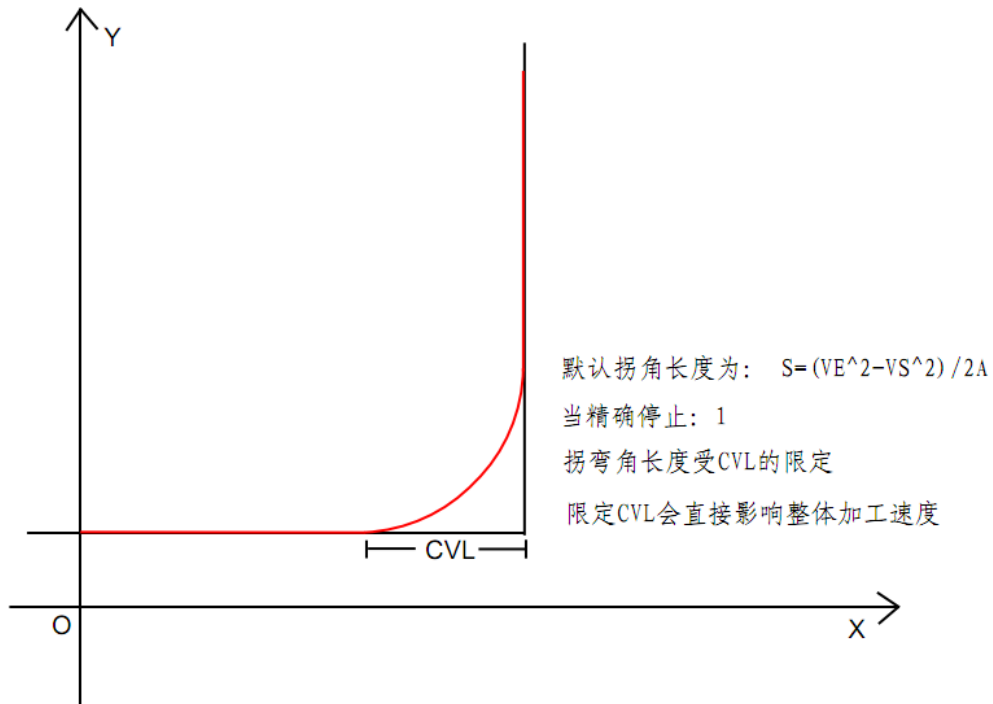

Advanced operating functions:



In standby (not running processing) for speed: Press and hold the stop button (黑四方键), while another swirling advanced function keys, you can directly adjust the speed percentage, on the main screen you can see the speed percentage (I: 100-1) display.

In the processing operation, direct swirling advanced function keys, you can adjust the speed of the percentage, on the main screen you can see the speed percentage (I: 100-1) display.

In standby (not running processing) for speed: Press and hold the stop button (black square button) while pressing the middle button Advanced function keys can switch to adjust the spindle speed and running speed. It can directly press the middle button to adjust runtime as shown:



(Specific feature factory mode)

1: Open the F1, F2, F3, F4, F5

OUT1-5 manual control function, specify a password for: 033,501

Open,

033500 closed.

2: The soft limit on the workpiece coordinate, MODE: 1 (default).

Password: 085601.

Soft limit based on mechanical coordinates, MODE: 0 password is:
085600.

3, the system initialization parameters: password: 100001.

4, machine system parameters stored in the TF card: password:

001001.

TF card data within bounce Machine: password: 001000.

5, change the order of returning to mechanical origin axis mode:

password: 83156 *

*, 0ZXYZ, 1ZAXY, 2ZYXA, 3XYZA, 4XZYA, 5YXZA, 6YZXA, 7AZXY, 8AZYX, 9AXYZ, * ZXZA (default).

G command interpretation

G00

Format: G0X .. Y. Z ... A

Axis rapid traverse, G0 for fast positioning tool, No machining of the workpiece. Can quickly move in several axis simultaneously, thereby producing a linear trajectory (point to point) as shown. Machine data specified maximum value for each axis rapid traverse rate of an axis running speed on this fast-moving. the moving speed of the synthesized vector speed of the two axes. In the address programmed feed rate F is invalid with G0 move quickly. The system will be run by the maximum value of each axis vector synthesis rate.

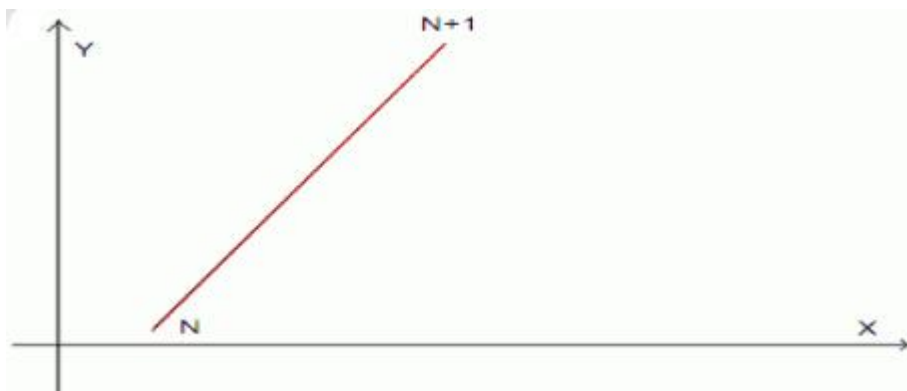

To go four cases:

G0X0Y0Z0

G0X10

G0Y10

G0X0

G0Y0

G01

Format G1X .. Y.. Z.. A.. F..

The tool moves on a straight line from the starting point to the target point, Programming with F feedrate speed. All axes can be run simultaneously. G1 remain valid until they are replaced by other commands.

This controller support multi-micro multi-line forward control interpolation algorithm, That is more than one segment will be calculated tracks as Continuous interpolation algorithm, To achieve a smooth transition, Prospective method and will increase the operating speed as much as possible.

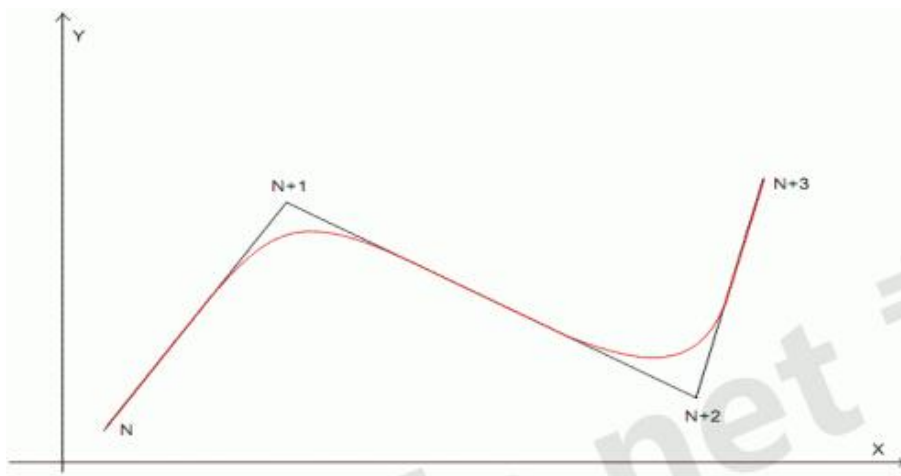

Red trace is the actual running tracks, F is the processing speed

Painting Quartet Case:

G0X0Y0Z0

X10F1200

Y10

X0

Y0

G02 G03

Format (1) G02X .. Y.. Z.. R.. F.. (Radius method)

(2) G02X .. Y.. Z.. I.. J.. K.. F (circle center method)

Format (1) G03X .. Y.. Z.. R.. F.. (Radius method)

(2) G03X .. Y.. Z.. I.. J.. K.. F (circle center method)

G02 clockwise circle G03 counterclockwise circle

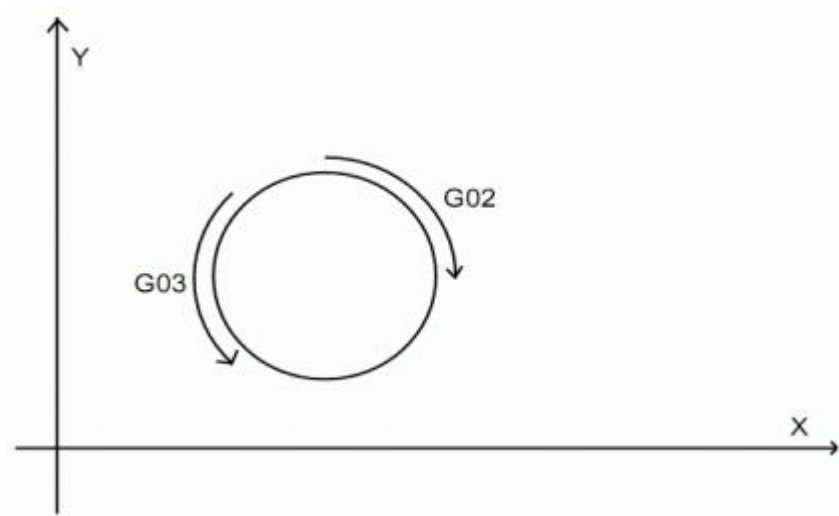

G17 (X, Y) coordinate plane (plane default)

G18 (X, Z) coordinate plane

G19 (Y,Z) coordinate plane

circle center method:

G02 (G03) X.. Y.. Z.. I.. J.. K.. F

X. Y. Z represents Terminal point coordinate, F processing speed

I represents projection of the arc starting point to circle center distance in the X-axis

J represents projection of the arc starting point to circle center distance in the Y-axis

K represents projection of the arc starting point to circle center distance in the Z-axis

L, J, K direction is corresponding to the negative direction of the XYZ

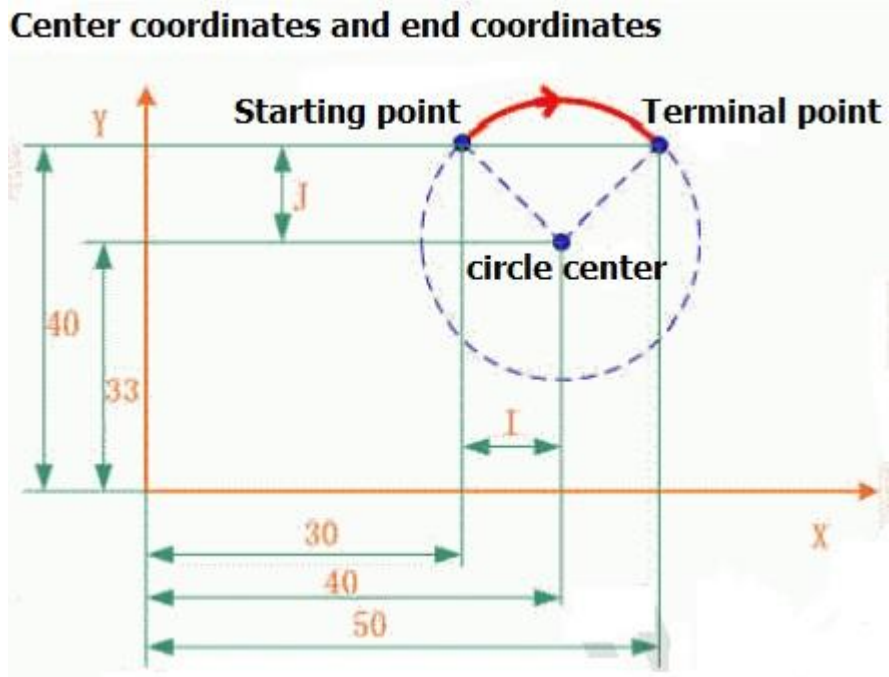

Legitimacy of the parameter (in XY plane):

circle center method can be obtained directly radius $R = \sqrt{i^2 + j^2}$, If the length of the line start and end points of the arc is greater than $2R$ is impossible to go wrong prompt.

When the above conditions are satisfied, the system will recalculate the center coordinates of the most reasonable, When it has some deviation with given center coordinates actually, Called super difference, If this deviation value is greater than the system given, it will prompt an error, This super difference can be set in the system, Facilitate more rapid input parameters.

(Note: The difference between the actual center of the arc can constitute

And input circle center called super difference, This difference can be super-max settings, you can tolerate a wider parameter input limit)

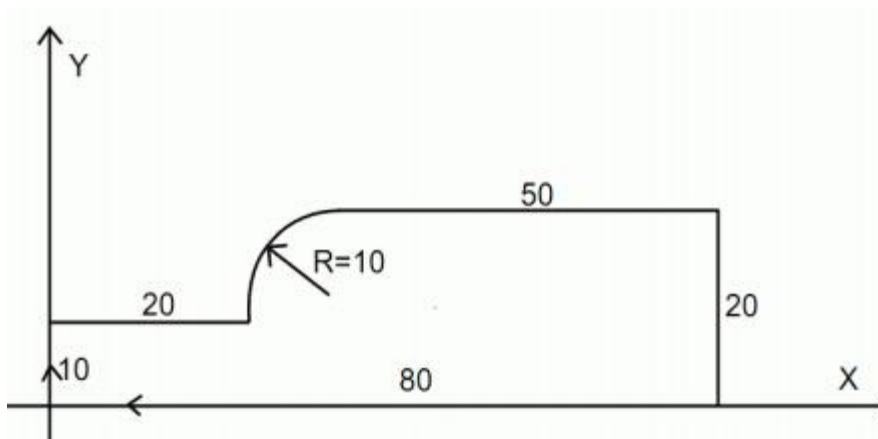

Case:

G0X0Y0Z0

G1Z-1F1200

Y10

X20
G02X30Y20I10J0
G1X80
Y0
X0
G0X0Y0Z5

Radius method:

G02 (G03) X.. Y.. Z.. R.. F..

Radius and end point

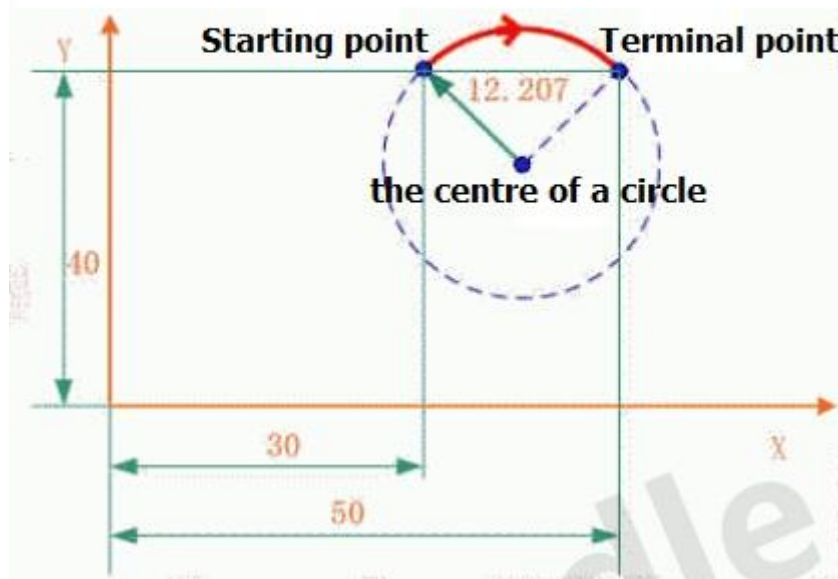

X, Y, Z Terminal point coordinates, F processing speed

R represents the radius of the arc

F processing speed

In the case of a known start and end points of the arc with a radius of programming, By geometric mapping will be two arcs, a large arc and a small arc, in order not to generate ambiguities provisions $R > 0$ is a small arc, $R < 0$ is great arc.

For full circle, because the starting point coincides with Terminal point, with R programming, there will be countless solution, can not define the center position, it can only be programmed with the center coordinates method.

case:

G0X0Y0Z0
G1Z-1F1200
Y10
X20

G02X30Y20R10
G1X80
Y0
X0
G0X0Y0Z5

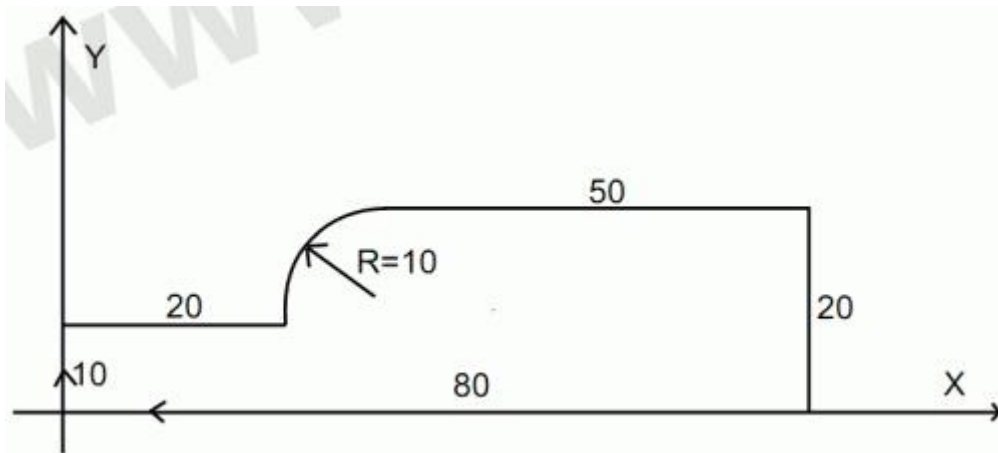

Chord length:

After the system calculates the combined resistance parameter, Given G02, G03 proposed synthesis and decomposition micro segment, This micro multi-segment shaped scale is Chord length, This length can be set in the system, Reference value (0.1mm-5mm),

Note: Due to system has prospective multi-micro multi-line interpolation calculation, and therefore Chord length is undesirable too short, when it is necessary to be too short, and processing speed must be somewhat lowered! !

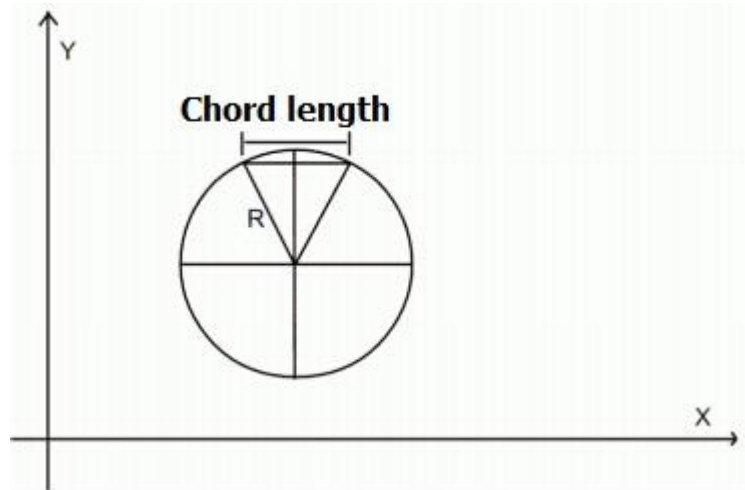

G17 (X, Y) coordinate plane (plane default)

G18 (X, Z) coordinate plane

G19 (Y, Z) coordinate plane

G04 (pause, delay)

Format: G04P ..

Between the two blocks by inserting a G4 block, You can make the given time of interrupt the

machining P suffix to be milliseconds, a minimum of 500ms + P *

Case: (delay 1 second)

G0X0Y0

G1Z-1F1200

G1X20Y20

G04P1000

G1X40Y40

G0Z5

G0X0Y0

G90 (default): Absolute dimensions

G91: Incremental dimension

G90 and G91 commands corresponding to the absolute position data input and incremental position data input. G90 represents the coordinate dimension of coordinates target point, G91 represents the displacement to be run. G90/G91 applies to all axes. These instructions do not decide to end position trajectory, Trajectory is determined by the other G group G function commands (G0, G1, G2, G3 ...). After the program starts G90 applies to all axes and remains active until later in the block have appeared G91.

G specific instructions:

G54 G55 G56 G57 G58 G59 (workpiece coordinate system)

Format: G54 G55 G56 G57 G58 G59

You can choose six different work coordinate

It is calculated based on the mechanical origin of the workpiece coordinate offset

Conditions of Use:

1 equipment mechanical origin

2 turned back once the mechanical origin (a return call can tie G28P3 mechanical origin)

On the main interface of G54 from red to yellow

After the above two conditions are satisfied, when each axis is automatically cleared

Memory current datum and offset mechanical machine origin and storage.

If the last memory had been the coordinate system, when the return to mechanical origin, will bounce coordinate value of the last memory.

G54 G55 G56 G57 G58 G59 坐标系图解

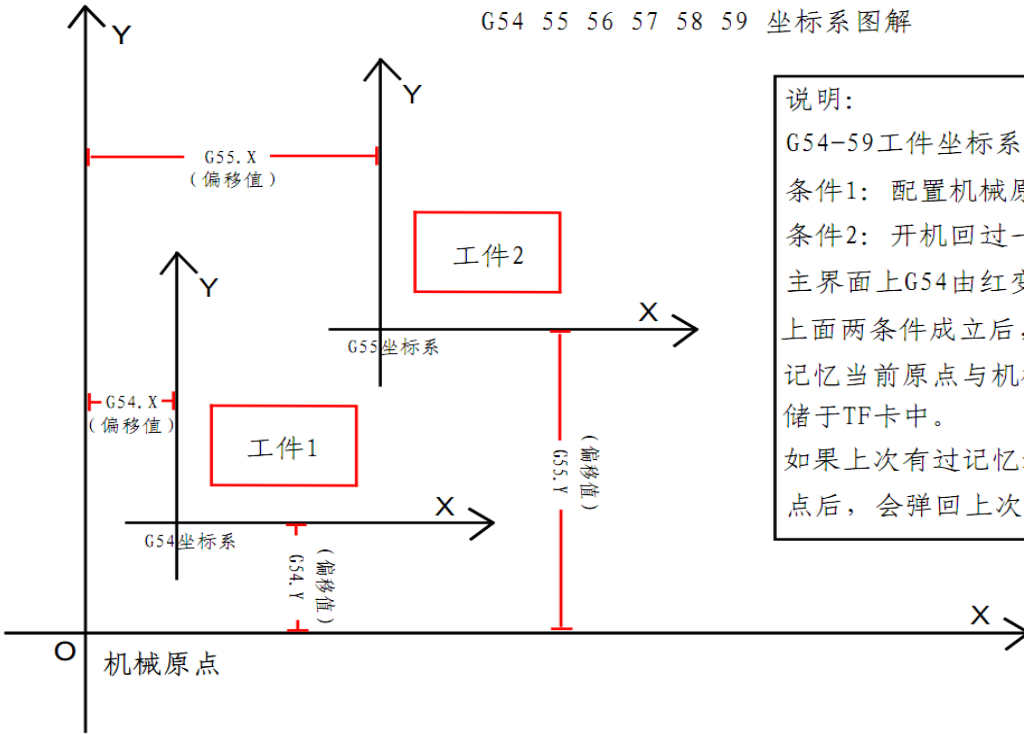

说明:
 G54-59工件坐标系是基于机械原点
 条件1: 配置机械原点
 条件2: 开机回过一次机械原点后才有效
 主界面上G54由红变黄
 上面两条条件成立后, 当每轴清零后会自动
 记忆当前原点与机械机原点的偏移值并存
 储于TF卡中。
 如果上次有过记忆过坐标系, 当回机械原
 点后, 会弹回上次记忆的坐标系值。

G54~59

G28: (coordinates back to the mechanical origin operation)

Format (four models):

G28XYZA

G28 P1X*Y*Z*A*

G28 P2X*Y*Z*A*

G28 P3XYZA

G28XYZA Will automatically return to mechanical origin after executing this command,

X, Y, Z, A can be individually write, such as the following are legitimate

- 1: G28X (expressed Press X mechanical origin)
- 2: G28XY (expressed Press XY mechanical origin)
- 3: G28Z

G28Y (the latter two combinations have prior instruction, he said they would first perform mechanical origin Z, Y after returning to mechanical origin)

G28P1X*Y*Z*A* After executing this command, will X, Y, Z, A axes corresponding value is assigned to the current coordinates.

example:

Such as the current coordinates: X100 Y100 Z50 A0

Code execution G28P1X200Y500Z10A20 the current coordinate value becomes:

X: 200

Y: 500

Z: 10

A: 20

G28P2X*Y*Z*A* After executing this command, will X, Y, Z, A axes

corresponding value assigned plus the current value of the axis, such as * to negative, performs subtraction.

Case:

Such as the current coordinates: X200 Y300 Z400 A500

Code execution G28P2X-20Y-500Z60A520 the current coordinate value becomes:

X: 180

Y: -200

Z: 460

A: 1020

G28P3XYZA

This instruction is only turned on, it did not hand back to the mechanical origin, to be effective, that G54 will be shown to be effective in red.

As performed back to mechanical origin, and then execute the entry instructions will be invalid.

Case :(boot did not back off mechanical origin)

1: G28P3X

X axis will automatically return to mechanical origin.

2: G28P3Y

Y-axis will automatically return to mechanical origin.

3: Can the many G28P3XYZA combination

(Power has been back to the mechanical origin)

1: G28P3X

invalid

2: G28P3Y

invalid

(Note: This instruction is mainly used in the operation coordinate system, and the establishment of a relationship between mechanical origin and artifacts from standard system, after power up and running again, did not return to prevent mechanical origin, arising from mistakes.)

G81: (drill instruction)

Format: G81X .. Y.. Z.. R.. F..

X.Y represent end coordinates, Z represents the depth of machining

F processing speed

R represent operating plane (safe altitude) at the beginning, represent and Z Terminal point after returned

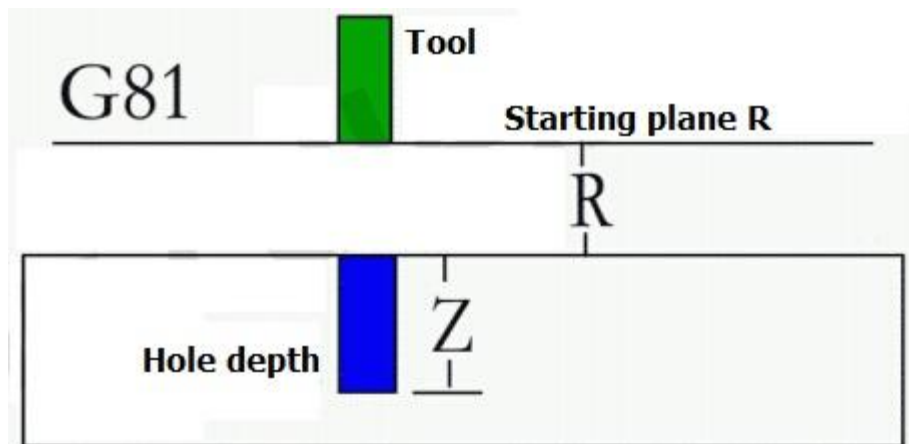

Case: (coordinates (20.0), (20.20), (0.20), (0,0) four drill holes 5mm in depth, the two safety plane, a speed of 200)

G0X0Y0Z5

G81X20Y0R2Z-5F200

G81X20Y20R2Z-5F200

G81X0Y20R2Z-5F200

G81X0Y0R2Z-5F200

G0X0Y0Z5

G82: (drilling instruction)

Format: G83X .. Y.. Z.. R.. P.. F....

X, Y represent Terminal point coordinates,Z represents the depth of machining, S represents dwell time at the hole bottom.

F processing speed

R represent theoperating plane of the beginning,and represent Z terminal point after returned.

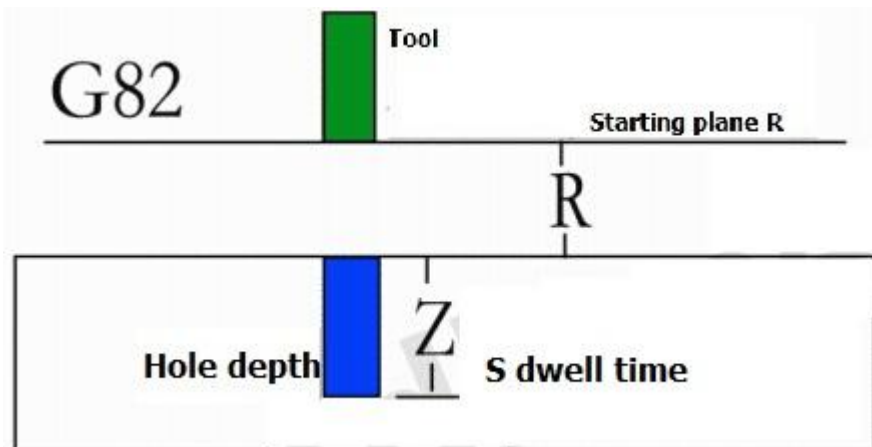

Case: (coordinates (20.0), (20.20), (0.20), (0,0) four drill holes 5mm in depth, the two safety plane, and one second stay at the hole bottom, a speed of 200)

```
G0X0Y0Z5
```

```
G82X20Y0R2Z-5P1000F200
```

```
G82X20Y20R2Z-5P1000F200
```

```
G82X0Y20R2Z-5P1000F200
```

```
G82X0Y0R2Z-5P1000F200
```

```
G0X0Y0Z5
```

G83: (canned cycle drilling instruction)

Format: G83X .. Y. Z. R. I. F....

X, Y represent end coordinates, Z represents the depth of processing, I represents the displacement of each fall, it will be cut back action When processed to I depth.

F processing speed

R represents the beginning of the start plane and said Z end after returned

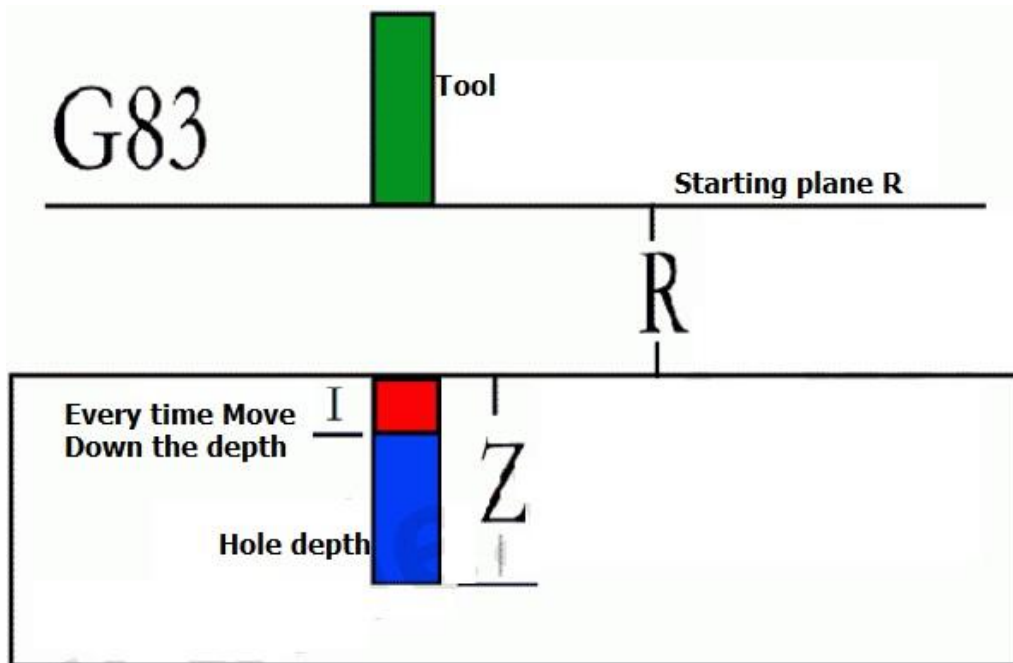

Case: (coordinates (20.0), (20.20), (0.20), (0,0) four drill holes 5mm in depth, the two safety plane,
G0X0Y0Z5
G83X20Y0R2Z-5I1F200
G83X20Y20R2Z-5I1F200
G83X0Y20R2Z-5I1F200
G83X0Y0R2Z-5I1F200
G0X0Y0Z5

M commands:

M00: Pause command, and will prompt "PAUSE" on the screen until you press Start to continue.
M03: turn off the inverted signal, and then open a spindle forward, it will be affected by the delay parameters of the open,
M04: turn off the forward signal, and then open a spindle reversal, will be affected by the delay parameter of the open
M05: spindle stop, to close the M03, M04.
M07: spray on, will be affected by the delay parameters of the open
M08: cooling Open, will be affected by the delay parameter of the open
M09: while closing the M07, M08;
M30: processing end, after no call. Exit.
M47: return to the first line, spin ring non-stop processing. Stop until you press stop or pause before exit.

specific M instructions:

The controllers do some advanced control with specific instructions M

M47 return to the first line to start again, can be added at the end of the program cycle not to stop.

Output Control M command (M1 **, M2 **)

M101 corresponds OUT_1 Output High Level (artificially high, Facilitate different voltage connect pull-up resistor)

M102 corresponds OUT_2 Output High Level (artificially high, Facilitate different voltage connect pull-up resistor)

M103 corresponds OUT_3 Output High Level (artificially high, Facilitate different voltage connect pull-up resistor)

M104 corresponds OUT_4 Output High Level (artificially high, Facilitate different voltage connect pull-up resistor)

M105 corresponds OUT_5 Output High Level (artificially high, Facilitate different voltage connect pull-up resistor)

M106 corresponds OUT_6 Output High Level (artificially high, Facilitate different voltage connect pull-up resistor)

M107 corresponds OUT_7 Output High Level (artificially high, Facilitate different voltage connect pull-up resistor)

M108 corresponds OUT_8 Output High Level (artificially high, Facilitate different voltage connect pull-up resistor)

M109 corresponds OUT_9 Output High Level (artificially high, Facilitate different voltage connect pull-up resistor)

M110 corresponds OUT_10 Output High Level (artificially high, Facilitate different voltage connect pull-up resistor)

M111 corresponds OUT_11 Output High Level (artificially high, Facilitate different voltage connect pull-up resistor)

M112 corresponds OUT_12 Output High Level (artificially high, Facilitate different voltage connect pull-up resistor)

M113 corresponds OUT_13 Output High Level (artificially high, Facilitate different voltage connect pull-up resistor)

M114 corresponds OUT_14 Output High Level (artificially high, Facilitate different voltage connect pull-up resistor)

M115 corresponds OUT_15 Output High Level (artificially high, Facilitate different voltage connect pull-up resistor)

M116 Because logic easy to confuse, so give up on the OUT_16 Output Control

M201 corresponding OUT_1 output low level (perfusion 500ma to ground)

M202 corresponding OUT_2 output low level (perfusion 500ma to ground)

M203 corresponding OUT_3 output low level (perfusion 500ma to ground)

M204 corresponding OUT_4 output low level (perfusion 500ma to ground)

M205 corresponding OUT_5 output low level (perfusion 500ma to ground)
M206 corresponding OUT_6 output low level (perfusion 500ma to ground)
M207 corresponding OUT_7 output low level (perfusion 500ma to ground)
M208 corresponding OUT_8 output low level (perfusion 500ma to ground)
M209 corresponding OUT_9 output low level (perfusion 500ma to ground)
M210 corresponding OUT_10 output low level (perfusion 500ma to ground)
M211 corresponding OUT_11 output low level (perfusion 500ma to ground)
M212 corresponding OUT_12 output low level (perfusion 500ma to ground)
M213 corresponding OUT_13 output low level (perfusion 500ma to ground)
M214 corresponding OUT_14 output low level (perfusion 500ma to ground)
M215 corresponding OUT_15 output low level (perfusion 500ma to ground)
M216 Because logic easy to confuse, so give up on the OUT_16 Output Control

Enter the judgment M command (M3 **, M4 **)

M301 corresponding the input terminal INTPU_1 Judgment if it is low level execute the next line, otherwise go on waiting
M302 corresponding the input terminal INTPU_2 Judgment if it is low level execute the next line, otherwise go on waiting
M303 corresponding the input terminal INTPU_3 Judgment if it is low level execute the next line, otherwise go on waiting
M304 corresponding the input terminal INTPU_4 Judgment if it is low level execute the next line, otherwise go on waiting
M305 corresponding the input terminal INTPU_5 Judgment if it is low level execute the next line, otherwise go on waiting
M306 corresponding the input terminal INTPU_6 Judgment if it is low level execute the next line, otherwise go on waiting
M307 corresponding the input terminal INTPU_7 Judgment if it is low level execute the next line, otherwise go on waiting
M308 corresponding the input terminal INTPU_8 Judgment if it is low level execute the next line, otherwise go on waiting
M309 corresponding the input terminal INTPU_9 Judgment if it is low level execute the next line, otherwise go on waiting
M310 corresponding the input terminal INTPU_10 Judgment if it is low level execute the next line, otherwise go on waiting
M311 corresponding the input terminal INTPU_11 Judgment if it is low level execute the next line, otherwise go on waiting
M312 corresponding the input terminal INTPU_12 Judgment if it is low level execute the next line, otherwise go on waiting
M313 corresponding the input terminal INTPU_13 Judgment if it is low level execute the next line, otherwise go on waiting

M314 corresponding the input terminal INTPU_14	Judgment if it is low level execute the next line, otherwise go on waiting
M315 corresponding the input terminal INTPU_15	Judgment if it is low level execute the next line, otherwise go on waiting
M316 corresponding the input terminal INTPU_16	Judgment if it is low level execute the next line, otherwise go on waiting
M401 corresponding the input terminal INTPU_1	Judgment if it is low level execute the next line, otherwise go on waiting
M402 corresponding the input terminal INTPU_2	Judgment if it is low level execute the next line, otherwise go on waiting
M403 corresponding the input terminal INTPU_3	Judgment if it is low level execute the next line, otherwise go on waiting
M404 corresponding the input terminal INTPU_4	Judgment if it is low level execute the next line, otherwise go on waiting
M405 corresponding the input terminal INTPU_5	Judgment if it is low level execute the next line, otherwise go on waiting
M406 corresponding the input terminal INTPU_6	Judgment if it is low level execute the next line, otherwise go on waiting
M407 corresponding the input terminal INTPU_7	Judgment if it is low level execute the next line, otherwise go on waiting
M408 corresponding the input terminal INTPU_8	Judgment if it is low level execute the next line, otherwise go on waiting
M409 corresponding the input terminal INTPU_9	Judgment if it is low level execute the next line, otherwise go on waiting
M410 corresponding the input terminal INTPU_10	Judgment if it is low level execute the next line, otherwise go on waiting
M411 corresponding the input terminal INTPU_11	Judgment if it is low level execute the next line, otherwise go on waiting
M412 corresponding the input terminal INTPU_12	Judgment if it is low level execute the next line, otherwise go on waiting
M413 corresponding the input terminal INTPU_13	Judgment if it is low level execute the next line, otherwise go on waiting
M414 corresponding the input terminal INTPU_14	Judgment if it is low level execute the next line, otherwise go on waiting
M415 corresponding the input terminal INTPU_15	Judgment if it is low level execute the next line, otherwise go on waiting
M416 corresponding the input terminal INTPU_16	Judgment if it is low level execute the next line, otherwise go on waiting

G, M instruction combinations Case

Project goal: to start the switch after triggered,X-axis control operation of the mobile speeds of 600, To specify the location of the first point A,output an action to pneumatic A,2 seconds,then semi-closed return,1 seconds, then move the operating speed of 600 to point B,Then output a

move to the Pneumatic B, 2 seconds, then closing the return, 1 seconds, then move the operating speed of 1200 to return to point A and wait for the start switch triggered

As shown in Figure

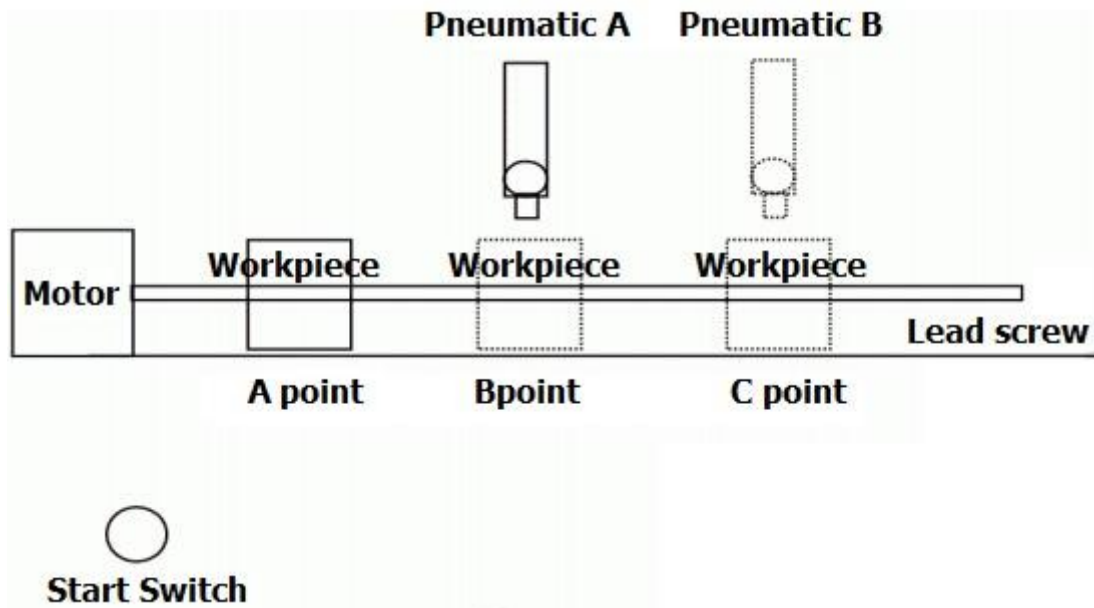

A position of the origin point, B point 500MM, C point 1000MM

connect the X-axis control all circuits, An input switch connected to the input port 1 as the start button, and connect the two-way Pneumatic units A, B to the output port 1, 2, A connect 1, B connect 2.

Program instructions are as follows:

G1X500F600 (the workpiece is moved to the 500 position)

M101 (Open Pneumatic A)

G4P2000 (delay 2 seconds)

M201 (Close Pneumatic A return)

G4P1000 (delay 1 second)

G1X1000F600 (the workpiece is moved to the 1000 position)

M102 (Open Pneumatic B)

G4P2000 (delay 2 seconds)

M202 (Close Pneumatic B returns)

G4P1000 (delay 1 second)

G1X0F1200 (the workpiece is moved to the 0 position)

M301 (wait for the start button triggered)

M47 (back to the first line to restart Note: The last line of the last to join the carriage return)

(Carriage return or empty)







